

## Keypad Switches

Excellent tactile feel when used with overlay membrane.

### Specifications KRS Series

Contact Rating: 50 mA 12VDC      Travel: 0.25mm  
 Operating Force: 160g (260g available)      Endurance: 10,000 cycles at 10 cpm

### KRS 0612 Series - Miniature and versatile thru hole mount.

Part Number	Dim. 'A'
41-KRS0612 / 4.3	4.3
41-KRS0612 / 5.0	5.0
41-KRS0612 / 7.3	7.3
41-KRS0612 / 9.5	9.5
41-KRS0612/13.0	13.0

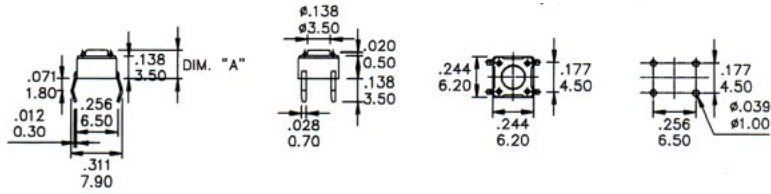

### KRS 12 Series - General Purpose Types with range of actuators. Positive Tactile Feel. Through Hole Mount. For SMD Versions add Suffix SMD.

Part Number	Height 'L' above PCB
41-KRS1243	4.3
41-KRS1275	7.5
41-KRS12120	12.0

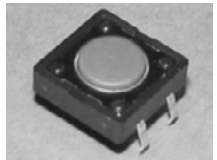
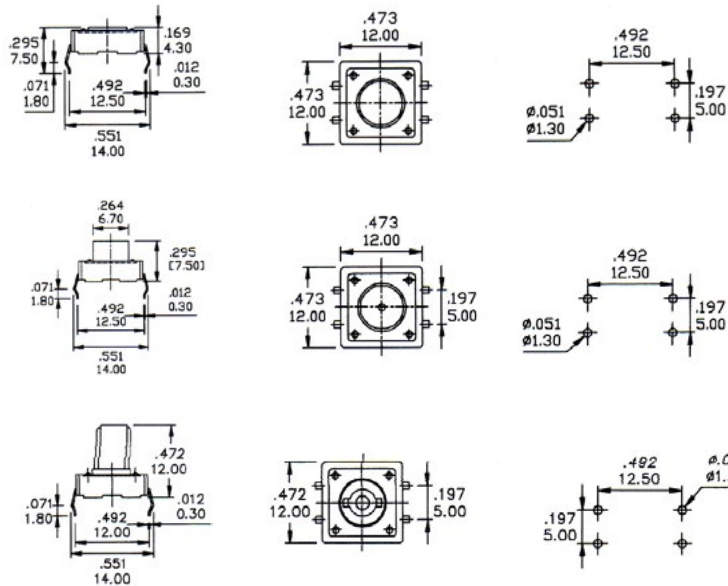

KRS1243



KRS1275



KRS12120

Drilling Patterns

### KRS 1273 - Switch can be used with spacers for a wide range of overlay heights.

Spacer Part No.	Spacer Nominal Length	'L' PCB to Overlay
Without Spacer	0	7.5
41-KS04.8	4.8	9.1
41-KS06.4	6.4	10.7
41-KS08.0	8.0	12.3
41-KS09.5	9.5	13.8
41-KS11.1	11.1	15.4

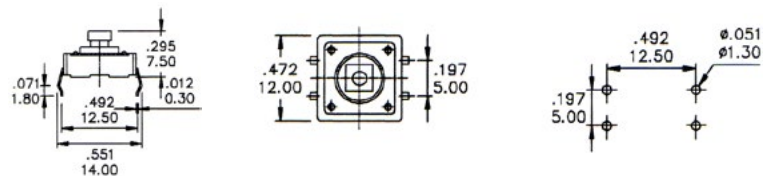

Drilling Pattern  
 Select spacer for reqd. dimension 'L'  
 Spacers must be ordered separately

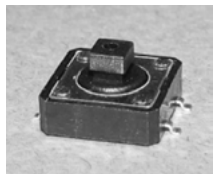

Part No. 41-KRS1273  
 SMD Version Part No. 41-KRS1273SMD

Non stock sizes up to 'L' = 42.4mm

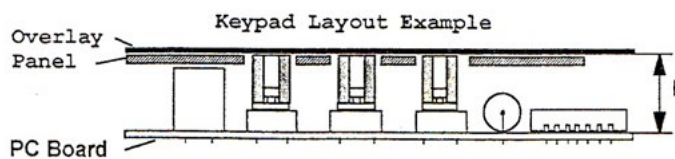
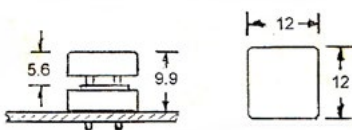

### Cap for KRS1273

To use as stand alone switch or keypad.